

Model: 8241/250-2
D80+D60

①

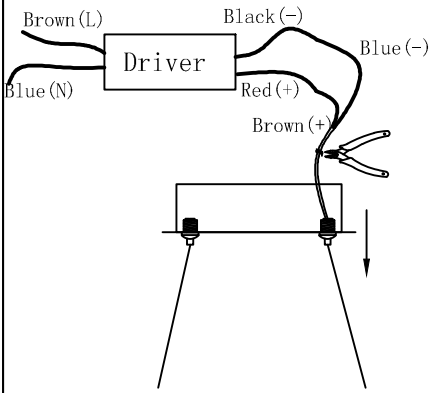

The driver is disconnected from the main power supply

②

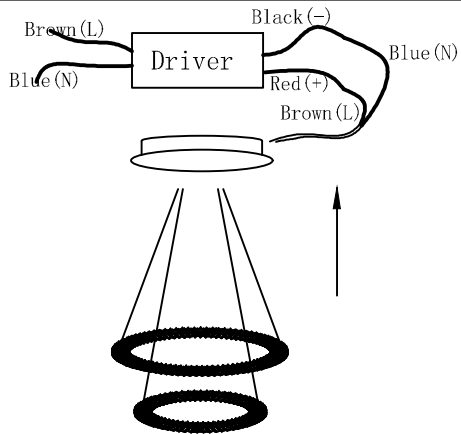

After each wire is wired, the matching drives are connected (note the positive and negative terminals). Finally, all the drive wires are combined into two sets of wires (brown and blue). The two sets of wires then connect to the power cord. Perform power-on test in a safe environment.

Install the wires from each ring to the corresponding holes in the suction tray from A to B (top to bottom) in the order shown in the drawing.

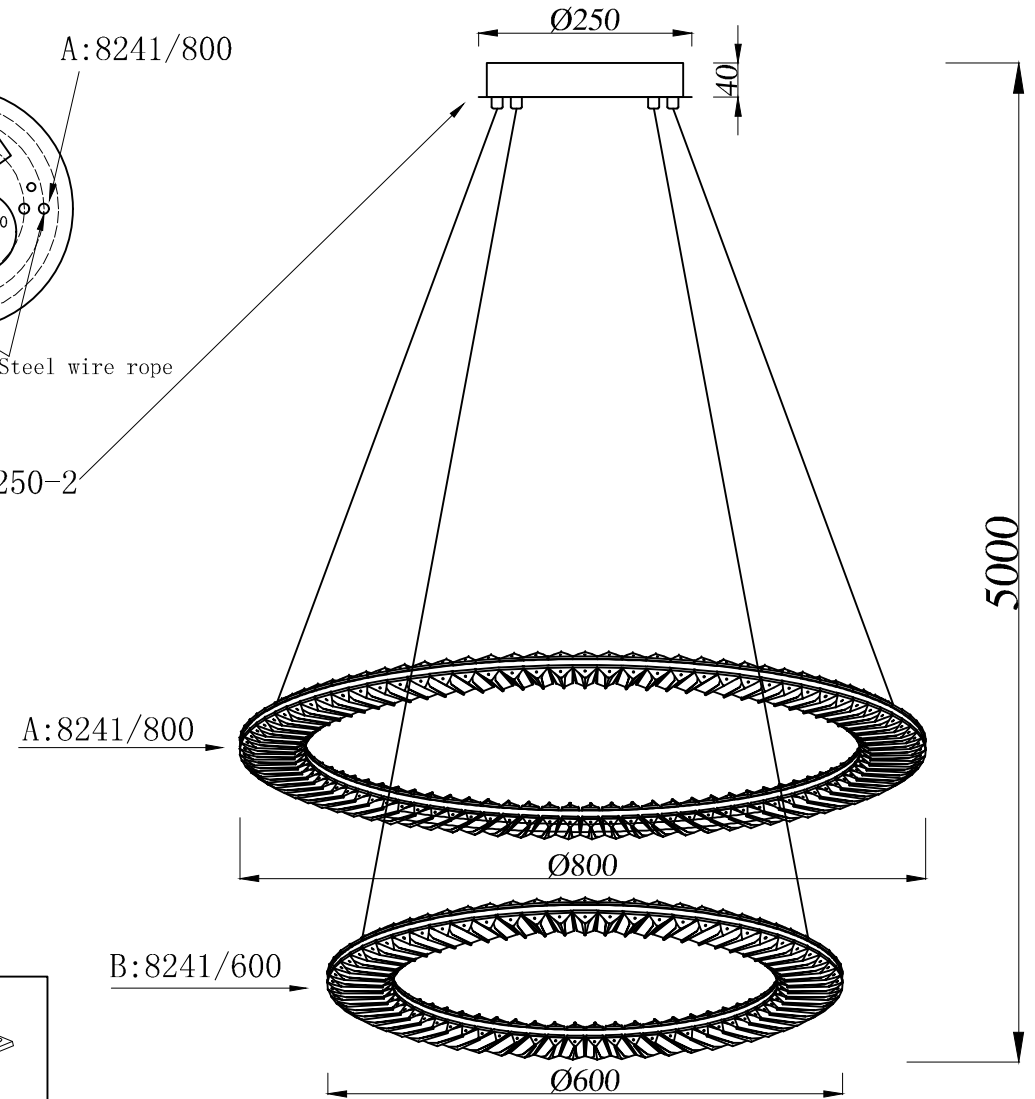
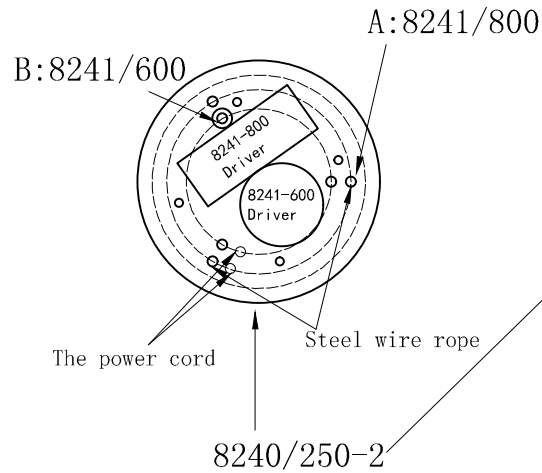
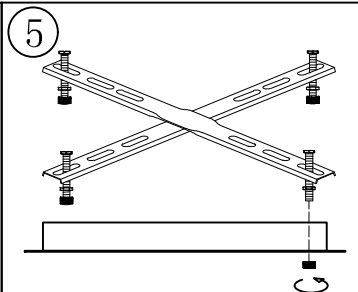
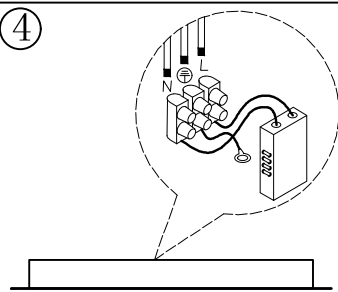
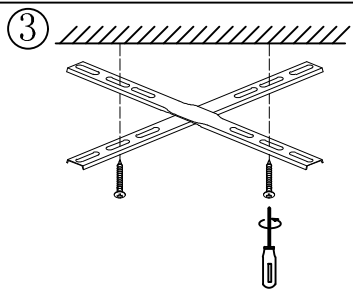

③

④

⑤